

Article number: 435700008

Description: Rota-fix shaft-hub connection K 8x18

Note: Self centering. Medium torque

Measures

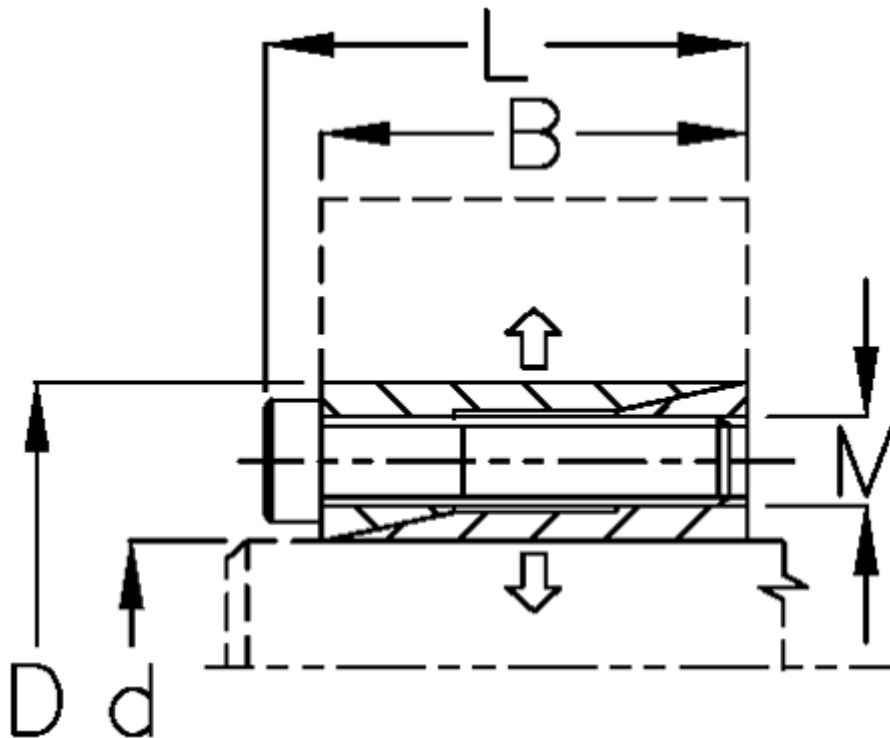

B mm	= 11
d mm	= 8.00
D mm	= 18
Fit tolerance	= Aksel h8, Nav H8
F kN torque	= 2.5
L mm	= 13.5
M mm	= M2,5
P N/mm ² surface pressure on shaft/hub	= 50

Surface roughness	= R? ? 3.2 µm
T N m torque	= 10
Ts N m bolt tightening torque	= 1.2